

# The Sun-Funnel Cooker

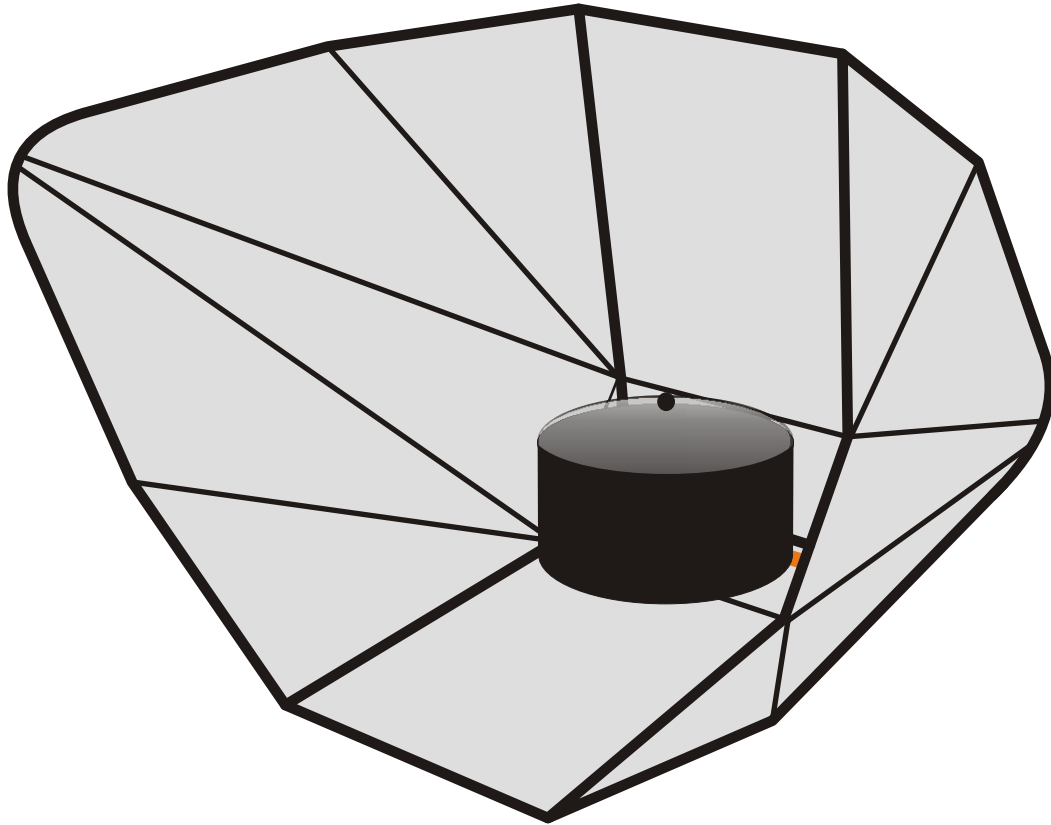

The Sun-Funnel cooker is similar to the Fun-Panel cooker, but with a different panel fold. The revised panel fold is necessary in order to form a rigid cooker base that is strong enough to support the cooking pot in an elevated, but more advantageous, position.

A stick, which traverses the lower section of the cooker, is added so that the cooking pot can be placed, as horizontally as possible, even after the cooker has been repositioned at a different pitch angle. This means that the cooker and the pot can now be easily repositioned to track the sun's movement for a more efficient cooking throughout the day.

The cooker can be constructed, in less than an hour, from a used cardboard box, a stick, some aluminum foil and some homemade glue. The plan and constructions steps for the Sun-Funnel cooker are provided in the following pages.

The size of this Sun-Funnel cooker is suitable for use with a 4-liter size black metal pot that has a tight fitting clear glass lid. A plastic oven bag can be used as a greenhouse enclosure for the pot if a black metal lid is to be used instead of a clear glass lid or when a higher cooking temperature is desired.

# The Sun-Funnel Cooker Plan

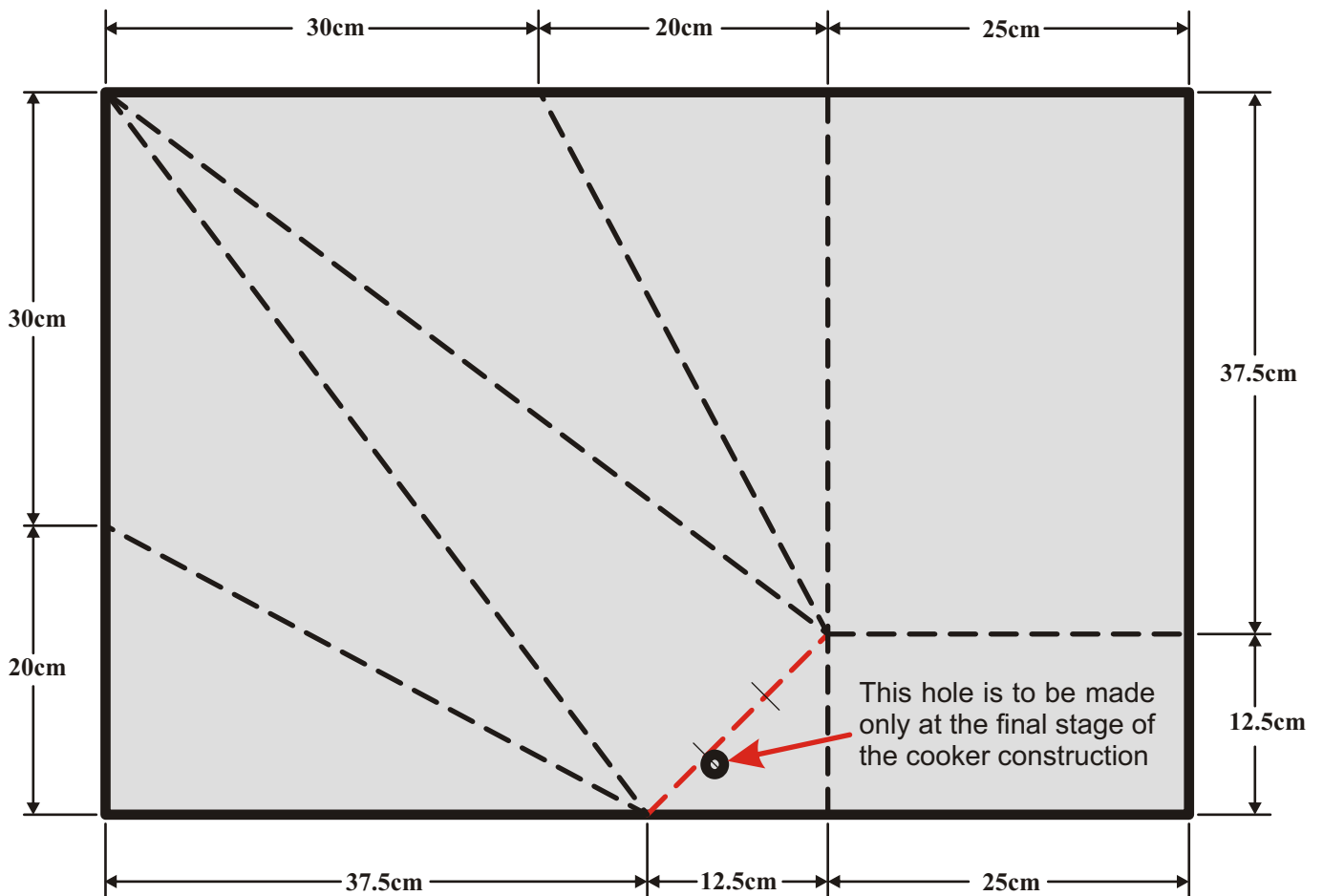

Attach aluminum foil to the cardboard. Draw and crease the fold lines.

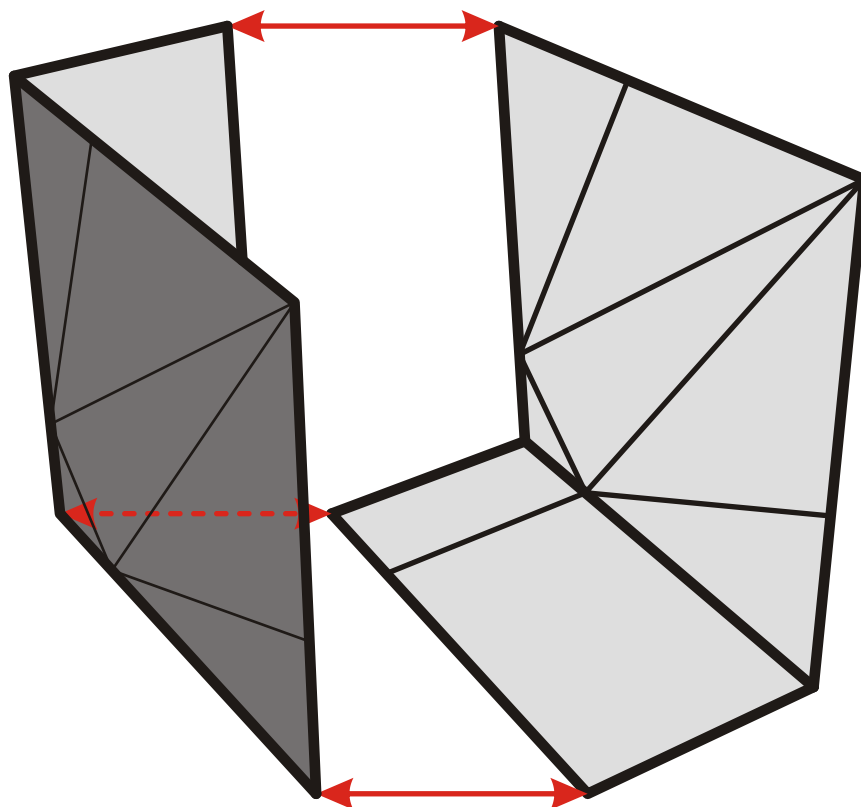

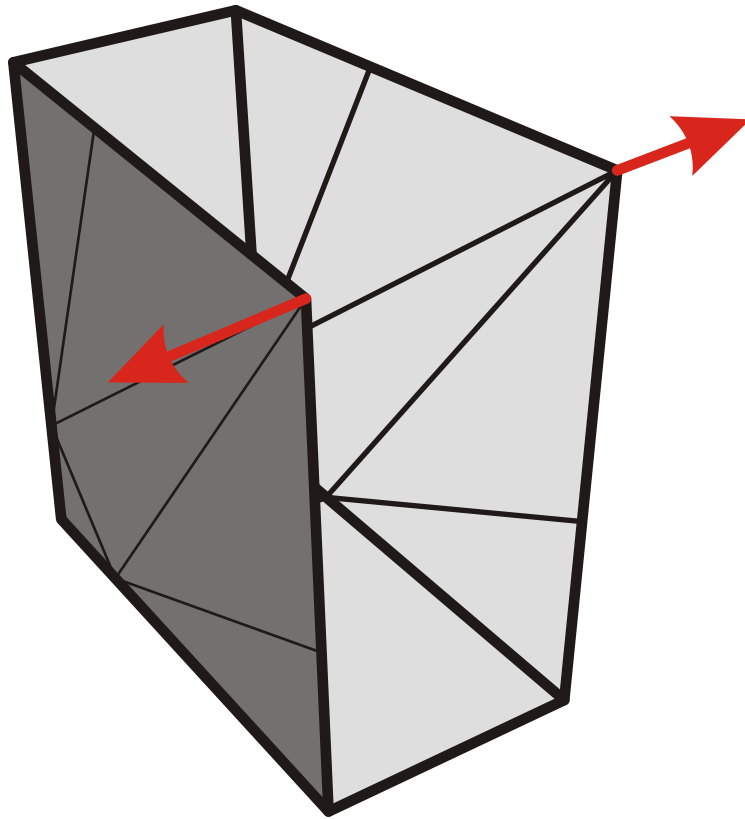

Spread open the reflectors in the arrow directions as shown.

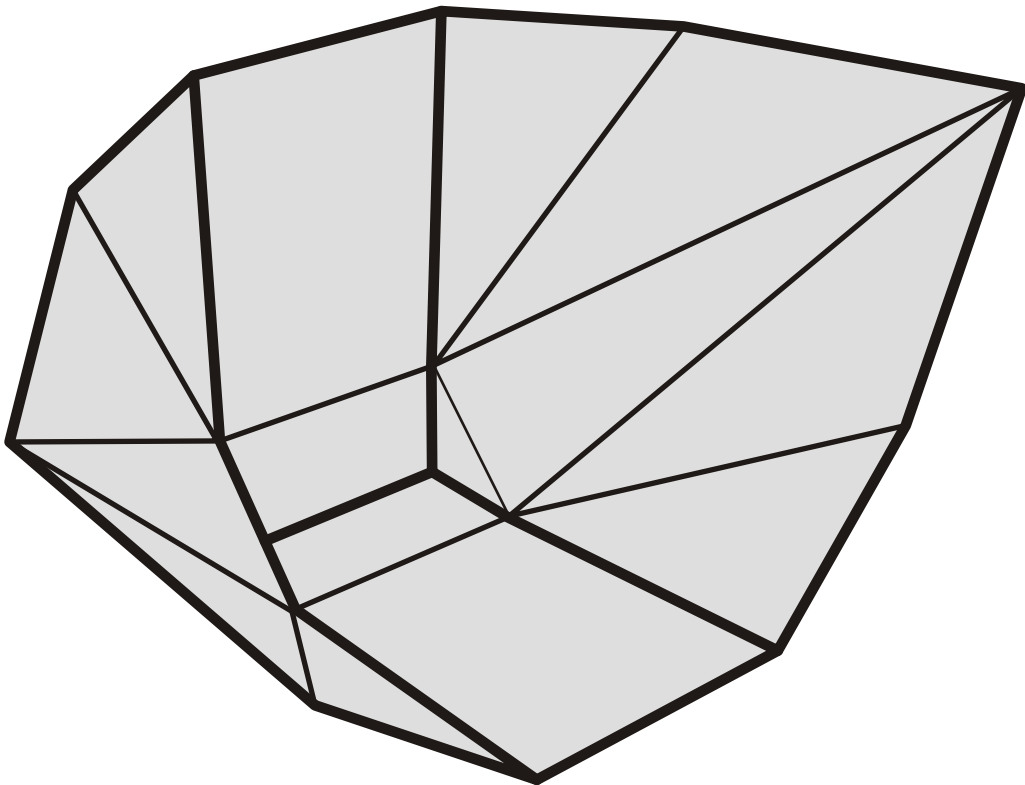

Make sure that all the fold lines are evenly bent to form a nice funnel shape.

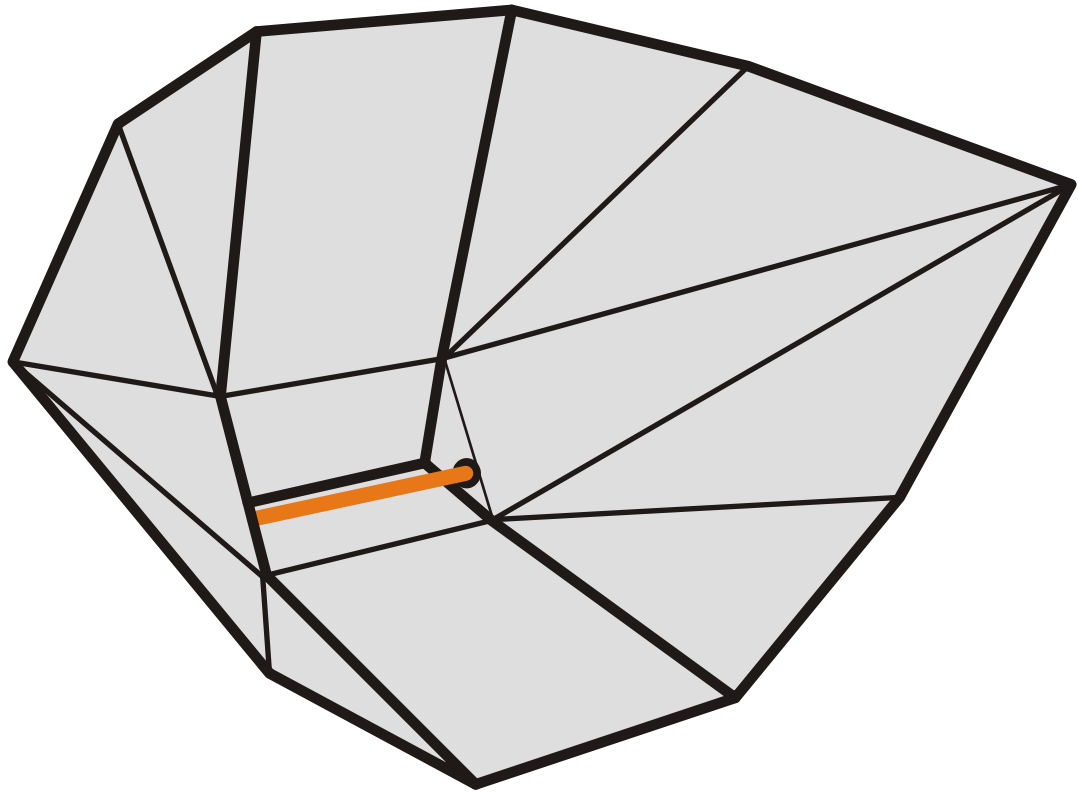

Make two through holes, on the lower side walls, and insert a round stick horizontally through the two holes as shown.

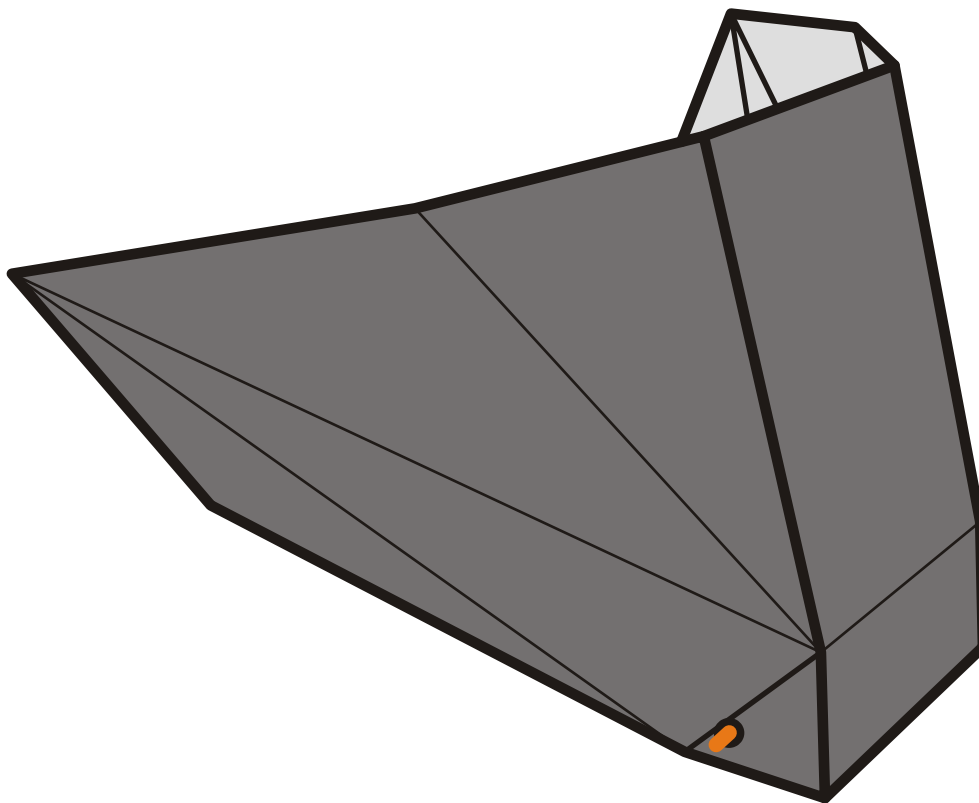

The stick protrudes slightly out of the sides of the cooker.

The stick provides support to keep the cooking pot in a horizontal position at various cooker pitch angles

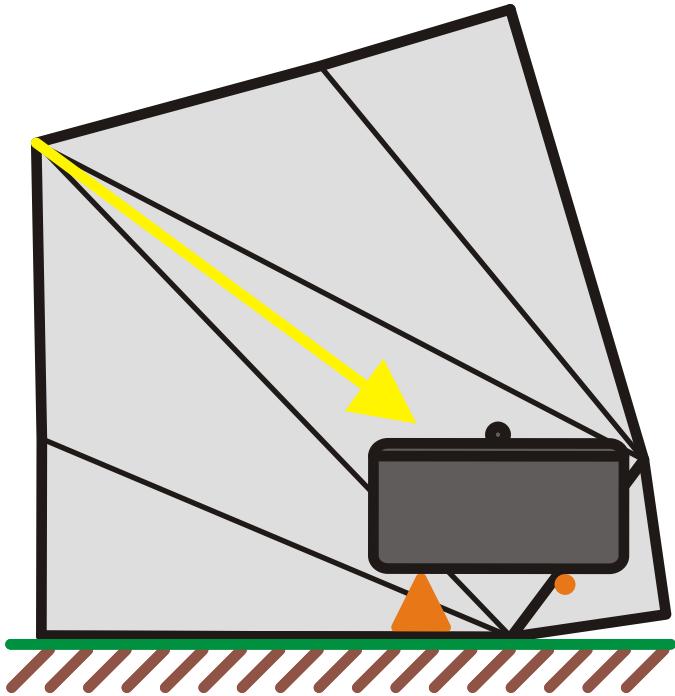

Low sun-angle

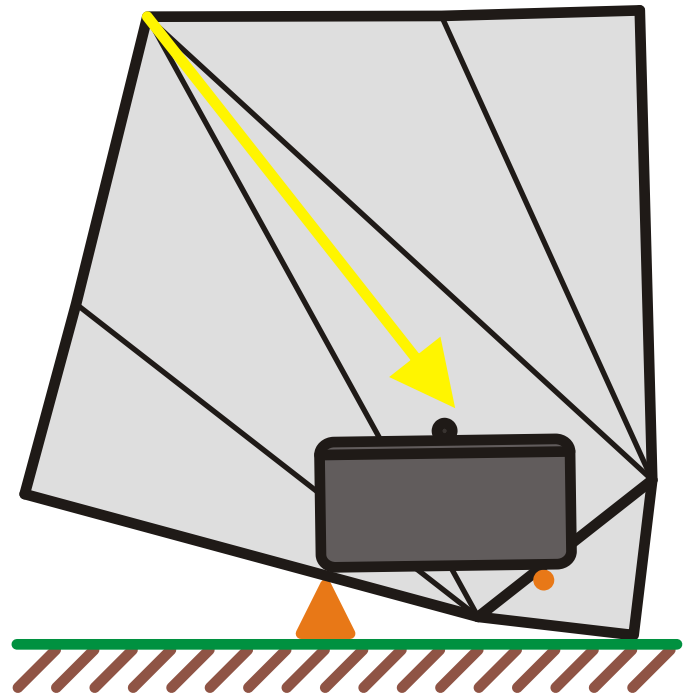

Medium sun-angle

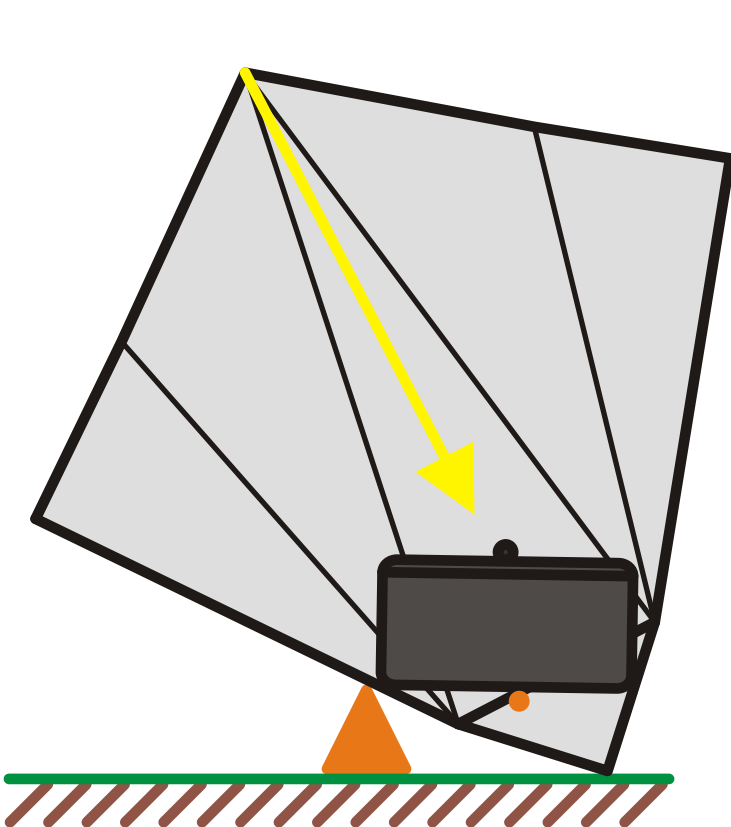

Medium sun-angle

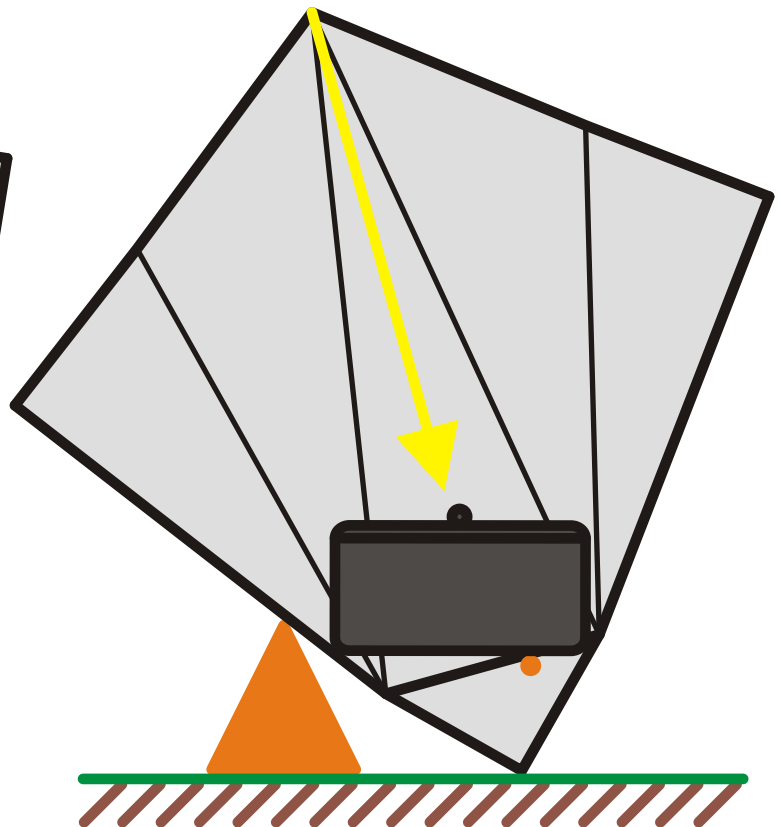

High sun-angle

The following pages are photos and the sequence of steps taken during the construction of my Sun-Funnel cooker



Obtain two pieces of cardboard from a used cardboard box. Cut them to the dimensions specified in the plan.



Glue aluminum foil on the two pieces of cardboard. First lay the foil on a clean flat surface, then spread the glue on the foil. Align and lower the cardboard on the glued foil. Press down to make foil stick to cardboard. Trim off any excess foil around the edges of the cardboard.



Draw the fold lines on the two pieces of cardboard and crease the fold lines with a straight edge. I use a small piece of metal angle to press down on the fold lines to make sharp and deep creases.

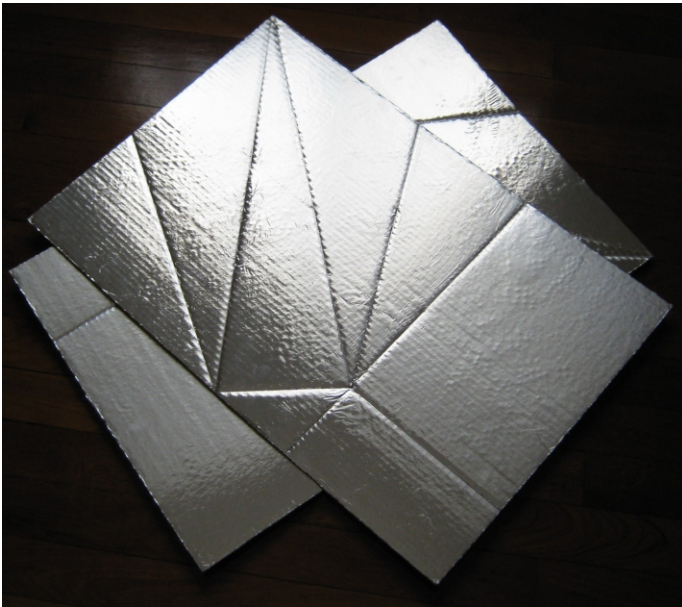

This photo shows the properly creased cardboard. Deep and sharp crease lines produce much better and cleaner folds.



Bend the two cardboard pieces to form two L-shape panels. Join the two L-shape panels together, as shown in the photo, using store bought tape or tape made from cardboard strips and glue.

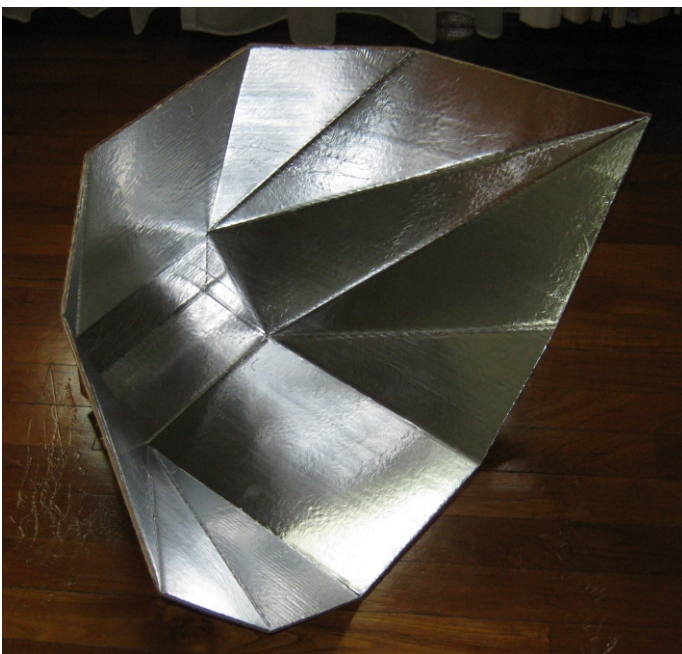

Spread open the two sides of the joined cardboard to form the desired funnel shape. Make sure that all fold lines are evenly bent to form an even funnel shape.

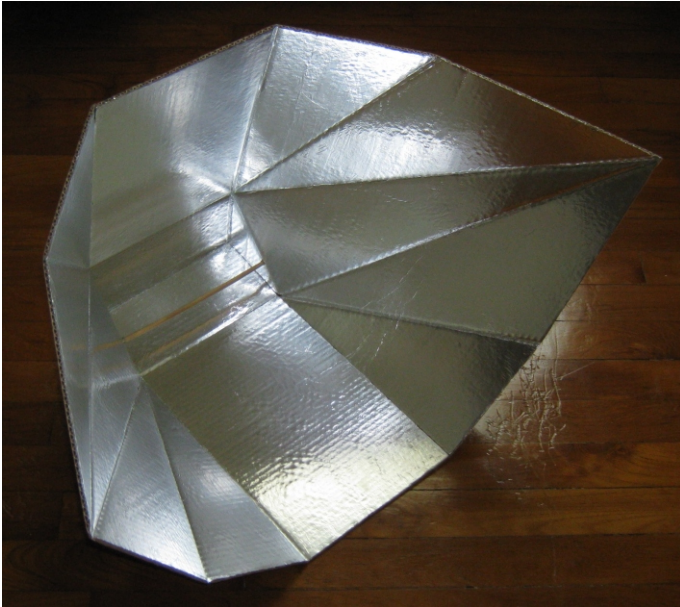

Make two through holes on the lower side walls of the cooker. Insert a stick through the holes. Both ends of the stick should protrude slightly out of the cooker.



Sun-Funnel cooker is shown in the low sun-angle position. The pot is supported by the stick at the back and a small cardboard wedge at the front.

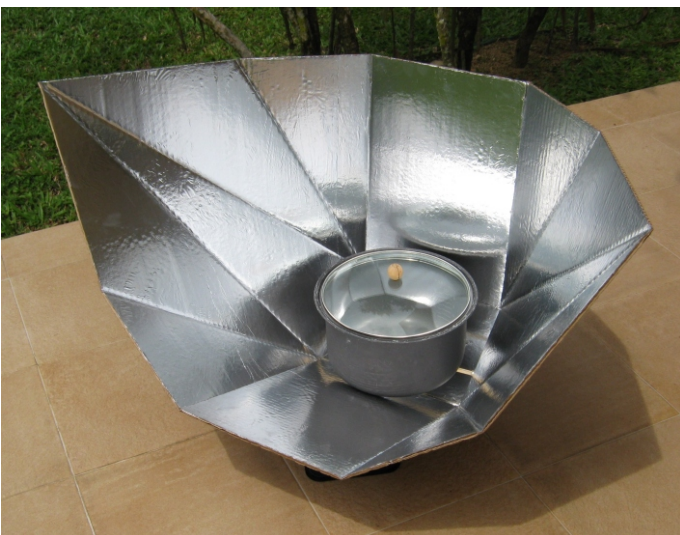

Sun-Funnel cooker is shown in the medium sun-angle position. The pot is supported by the stick at the back and resting against the cooker panel at the front.